

Article number: 0107081

Description: Retaining ring AK 68 DIN 983

Measures

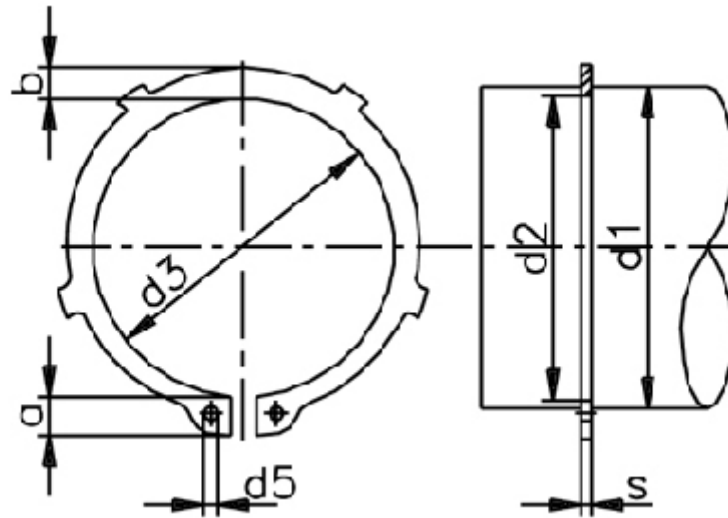

a max	= 10.2	FN kN	= 52.20	Number of serrations	= 8
AN mm ²	= 313.0	FRg kN	= 23.0	s	= 2.50
b	= 6.5	FR kN	= 135.0	t	= 1.50
d1	= 68	g	= 2.5	tol	= -0.30
d2	= 65.0	K kN-mm	= 244.0	tol	= -0.07
d3	= 63.5	m min	= 2.65	tol	= +0,46-1,10
d5 min	= 3.0	n abl x 1000	= 7	Tong	= ZGA-3
Description	= AK 68	Nominal drive	= 4.5	Weight kg/1000	= 23.50